

## The Cobra line of quality products includes:

CB Radios

microTALK® Radios

Radar/Laser Detectors

Safety Alert® Traffic Warning Systems

Mobile GPS Navigation Systems

HighGear® Accessories

CobraMarine® VHF Marine Radios

Power Inverters

Accessories

For more information or to  
order any of our products,  
please visit our website:

[www.cobra.com](http://www.cobra.com)

Nothing Comes Close to a Cobra®

English



**15 BAND**  
S - X R S

Operating Instructions



**IntelliLink™ Wireless Remote Series**  
**15-Band™ S-XRS™ Maximum Performance Digital Radar/Laser**  
**Detector with Red Light/Speed Camera GPS Locator\***

**XRS R8/R10G**

\*(Included with XRS R10G.  
Optional with XRS R8.)

Printed in China  
Part No. 480-497-P  
Version B

Nothing Comes Close to a Cobra®

English

## Important Information and Customer Assistance

Introduction

### Important Information

#### Safe Driving

Motorists are expected to exercise all due caution while using this product, and to obey all applicable traffic laws. Do not attempt to change settings of the unit while the car is in motion.

#### Federal Laws Governing the Use of Radar Detectors

It is not against federal law to receive radar transmissions with your Cobra® radar/laser detector. The Communications Act of 1924 guarantees your right to receive radio transmissions on any frequency. Local laws that contravene this Act, while illegal, may be enforced by your local law enforcement officials until and unless they are prohibited from doing so by federal court action.

#### Safety/Strobe Alert

Use of this product is not intended to, and does not, ensure that motorists or passengers will not be involved in traffic accidents. It is only intended to alert the motorist that an emergency vehicle equipped with a Cobra Safety Alert, 3M or Tomar strobe transmitter is within range as defined by that product. Please call local fire and police departments to learn if coverage exists in your area.

Some states and municipalities prohibit mounting any object on your windshield. If you drive in these states or areas; you can mount the MDU on the dash.

#### Security of Your Vehicle

Before leaving your vehicle, always remember to conceal your Remote Display Unit (RDU) in order to reduce the possibility of break-in and theft. Your Main Detector Unit (MDU) has a two-position bracket that, when in the up position, presents a very discreet profile from outside the vehicle.

Customer Assistance

### Customer Assistance

Use your owner's manual to learn about product features. Cobra Electronics offers the following customer assistance services:

#### For Assistance in the U.S.A.

**Automated Help Desk**, English only. 24 hours a day, 7 days a week 773-889-3087.

**Customer Assistance Operators**, English and Spanish, 8:00 am to 5:30 p.m. Central Time Mon. through Fri. (except holidays) 773-889-3087.

**Questions**, English and Spanish, Fax: 773-622-2269.

**Technical Assistance**, English only, [www.cobra.com](http://www.cobra.com).  
English and Spanish e-mail, [Productinfo@cobra.com](mailto:Productinfo@cobra.com).

**For Assistance Outside the U.S.A. Contact Your Local Dealer**

A1 English

©2009 Cobra Electronics Corporation™  
6500 West Cortland Street  
Chicago, Illinois 60707 USA  
[www.cobra.com](http://www.cobra.com)

The XRS R8 provides detection capabilities for radar, laser and strobe signals.

The XRS R10G has all the features of the XRS R8 plus a GPS locator module which provides alerts when approaching photo-enforced intersections, roads with fixed red light/speed cameras and caution areas (such as a high-accident intersection). The XRS R10G can store up to 1,000 additional user-programmable Location Alerts.

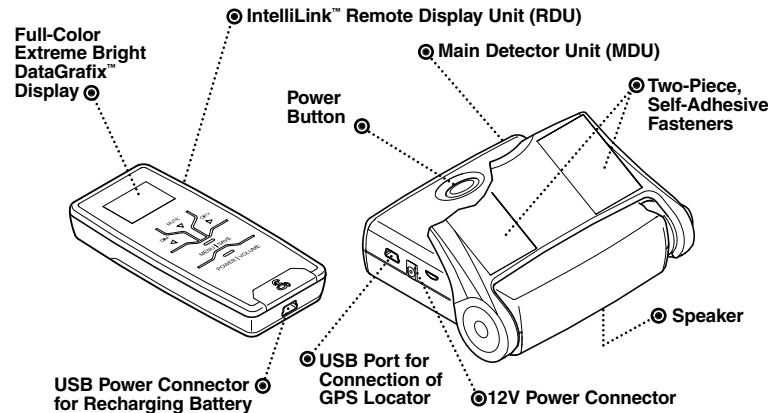

GPS Locator for Model XRS R10G (Optional for Model XRS R8)

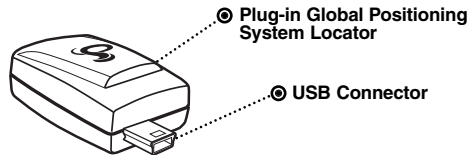

## Accessories In This Package

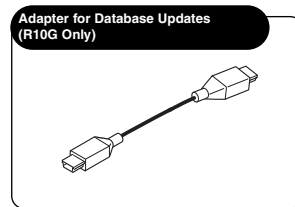
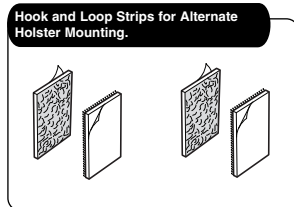
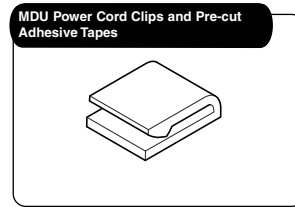
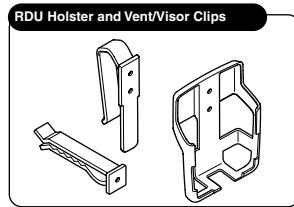
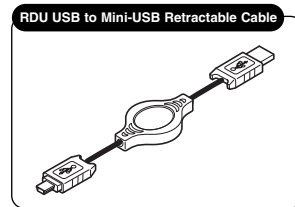
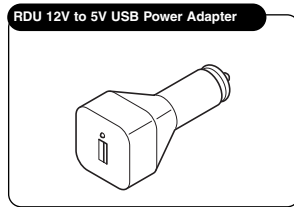
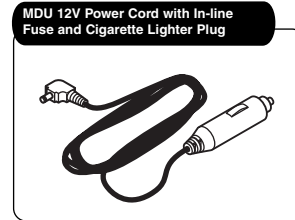
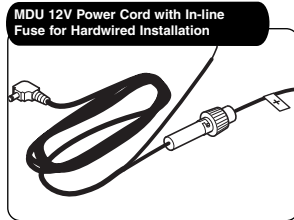

## Ordering From U.S.A.

Call 773-889-3087 for pricing or visit [www.cobra.com](http://www.cobra.com).

### For Credit Card Orders

Call 773-889-3087 [Press one from the main menu] 8:00 a.m. to 5:30 p.m. Central Time, Monday through Friday.

### Make Check or Money Order Payable To

Cobra Electronics, Attn: Accessories Dept.,  
6500 West Cortland Street, Chicago, IL 60707 U.S.A.

### To Order Online

Please visit our website: [www.cobra.com](http://www.cobra.com)

Item #	Description
CLP-2B	Dual Port Power Adapter
RDA GPSL55	GPS Locator Upgrade (for Model XRS R8 Only)
RDA LIBP	LiON Replacement Battery Pack
RDA RDU	Replacement RDU

## Trademark Acknowledgement

Cobra®, DigiView®, EasySet®, Extra Sensory Detection®, IntelliMute®, IntelliMute® Pro, IntelliShield®, LaserEye®, Nothing Comes Close to a Cobra®, Safety Alert® Traffic Warning System, Strobe Alert®, VG-2 Alert®, Xtreme Range Superheterodyne® and the snake design are registered trademarks of Cobra Electronics Corporation, USA.

Cobra Electronics Corporation™, 14 Band™, 15 Band™, Extreme Bright DataGrafix™, IntelliLink™, IntelliScope™, IntelliView™, Revolution™ Series, SmartPower™, Spectre Alert™, Super-Xtreme Range Superheterodyne™, S-XRS™, UltraBright™, and Voice Alert™ are trademarks of Cobra Electronics Corporation, USA.

Opticom™ is a trademark of 3M Corporation. Instaclear® for Ford is a registered trademark of Ford Motor Company, Inc. Electriclear® for GM is a registered trademark of General Motors Corporation. 20-20™ and Ultra-Lyte™ are trademarks of Laser Technology, Inc. ProLaser™ and ProLaser III™ are trademarks of Kustom Signals, Inc. Bee III™ and Pop™ are trademarks of MPH Industries. Stalker™ LIDAR is a trademark of Applied Concepts, Inc. Spectre I™ and Spectre IV+™ are trademarks of Stealth Micro Systems Pty. Ltd. SpeedLaser™ is a trademark of Laser Atlanta, LLC. Interceptor VG-2™ is a trademark of TechniSonic Industries LTD. Tomar® is a registered trademark of TOMAR Electronics, Inc.



## **Introduction**

Important Information .....	A1
Customer Assistance .....	A1
Controls, Indicators and Connections .....	A2
Accessories In This Package .....	A3
Product Overview .....	2
Installation Overview .....	4

## **Your Detector**

Installation .....	7
Controls and Display .....	15
Getting Started .....	17
Programming .....	21
Program Navigation .....	22
Settings .....	24
Detection Alerts .....	29
Radar and Laser .....	36
Maintenance .....	38
Specifications .....	39

## **Customer Assistance**

Product Service .....	40
-----------------------	----

## **Warranty**

Warranty .....	41
----------------	----

## **User License**

User License .....	42
--------------------	----

## **Optional Accessories**

Optional Accessories .....	44
Accessories Order Info .....	45

## **Trademarks**

Trademark Acknowledgement .....	45
---------------------------------	----

## Cobra XRS R8 and XRS R10G



### CAUTION

Modifications or parts not approved by Cobra Electronics Corporation may violate FCC Rules and void authority to operate this equipment.

### Registering Your Detector

To register your Cobra XRS R8 or XRS R10G go to [www.cobra.com](http://www.cobra.com). Click on the Product Registration tab.

Read and understand the information in the **Installation Overview** and **Installation** sections of this manual for best operation.

The XRS R8 consists of a Main Detector Unit (MDU) and a wireless Remote Display Unit (RDU). The XRS R10G adds a Global Positioning System Locator module, providing fixed red light/speed camera and caution area location-based alerts. The XRS R8 can be upgraded with the optional Cobra GPS Locator to provide fixed red light/speed camera and caution area location-based alerts.

### Main Detector Unit (MDU)

The MDU is equipped with an adjustable, two-position bracket for detection operation in the down (horizontal) position or in the up position for a less visible profile from the outside. The MDU issues audible messages during power-on and self-testing. The MDU is equipped with a power button to turn the unit On and Off.

The MDU contains detection function sensors so proper mounting and orientation are important.

### Remote Display Unit (RDU)

The RDU is a wireless remote controller/display module that shows alerts detected by the MDU. The RDU display uses an Extreme Bright DataGrafix™ (Organic Light Emitting Diode) Display to show large graphical alerts as signals are detected.

The RDU uses a rechargeable lithium-ion (LiON) battery and is supplied with a holster and clips for mounting on heating/air conditioner vents or sun visor. A 12V to 5V USB Power Adaptor with cigarette lighter plug and a USB to Mini-USB Retractable Cable are supplied. The RDU can be charged in the vehicle using these two components or by plugging the USB to Mini-USB Retractable Cable to the USB port of your personal computer.

The normal Auto Dark screen is almost completely dark with only a moving dot. The Auto Dark screen provides discreet usage and helps conserve RDU battery life. The display color can be changed to match most dash illumination.

### Global Positioning System Locator – (XRS R10G Only)

The GPS Locator module tracks vehicle location. It uses a database that provides alerts as you approach photo-enforced intersections, roads with fixed red light/speed cameras and caution areas.

Use the GPS Locator functions to program alerts and store up to 1,000 user programmable Location Alerts. Software will be available to update the database and stay current with future photo enforced locations and caution areas. The GPS Locator module has no external controls and plugs into the MDU.

### GPS Database Information

When a GPS Locator unit is installed, you can view the version and date on which the installed database of Photo Enforcement and Caution Area Locations was updated. To update the database, go to Cobra's website (<http://aura.cobra.com>) and follow the online instructions.

## Mount Unit

### Main Detector Unit (MDU)

**Note:** To power the MDU, use one of the two power cords provided (See Page A3).

- **12V Power Cord with In-line Fuse for Hardwired Installation:**  
For connection to vehicle's fuse box or battery, or
- **12V Power Cord with In-line Fuse and Cigarette Lighter Plug:**  
For connection to 12-volt vehicle accessory outlet (cigarette lighter plug).

Fuse box hard wiring is recommended. Use this configuration to provide a more discreet installation. **If you are unsure about making this connection yourself, contact a professional installer. Cobra does not warrant any damages to the product or vehicle that may occur as a result of improper installation.**

#### On a negative grounded vehicle:

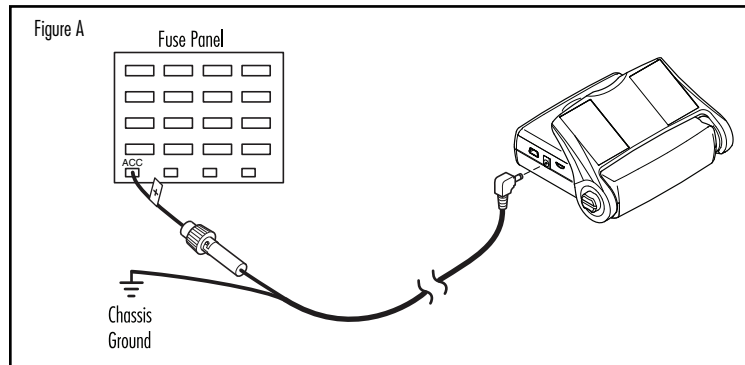

1. Connect the positive wire [marked with a tag (+)] of the DC power cord to an accessory 12V fuse that is controlled by the ignition switch (Figure A).
2. Connect negative wire (-) to a chassis ground location (Figure A). Body paint may need to be removed to assure a good ground connection.

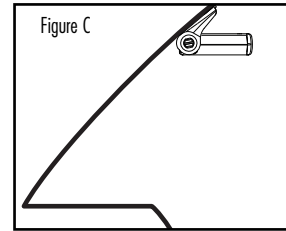
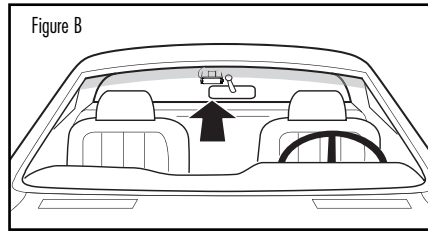

Mount the MDU high on windshield to right of rear view mirror (Figure B). The MDU must have a clear view through the windshield, **be parallel to the road** (Figure C) and have clearance to snap into the "up" position.

Position the MDU for easy access to power switch, cable connections and for mirror movement. Mount the MDU on the windshield close to the headliner. (See page 7 for details.)

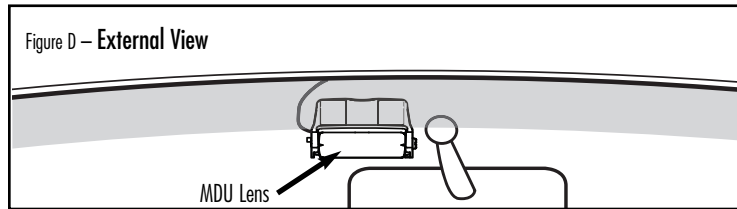

**IMPORTANT:** Do not block the MDU lens with the sun-shaded area of the windshield (Figure D).

Heated windshields currently available on some vehicles (Instaclear for Ford, Electriclear for GM), may block or weaken incoming signals. Consult your automobile manufacturer.

## Global Positioning System Locator – (XRS R10G Model Only)

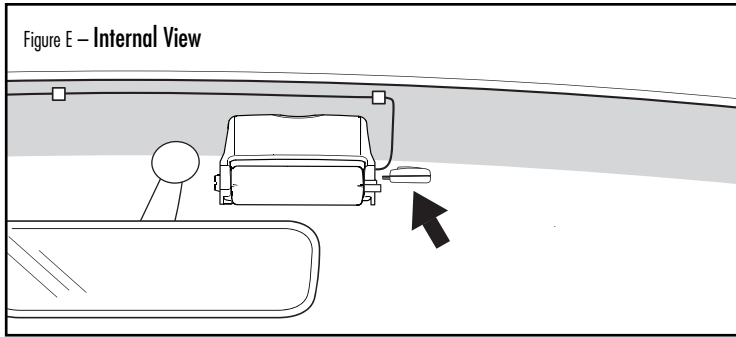

Mount the GPS Locator module to the MDU by plugging it into the USB port.

## Main Detector Unit (MDU)

<p><b>1.</b> Position MDU before actual mount.</p> <ul style="list-style-type: none"> <li>• Do not attempt to adjust MDU bracket.</li> <li>• Hold unit in place.</li> <li>• Using non-permanent pen, mark two opposite corners.</li> </ul>	
<p><b>2.</b> Peel off film from two-piece fastener strips. Align with two corner markings made in step 1. Press MDU bracket against windshield.</p> <ul style="list-style-type: none"> <li>• Fastener strips cannot easily be removed. Strength of adhesive strips increases with time.</li> <li>• Do not pull on MDU for first 20 minutes.</li> </ul>	

1. Loosen MDU bracket adjust knob (gray).

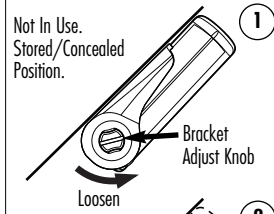

2. Adjust module to a position **parallel to the road**.

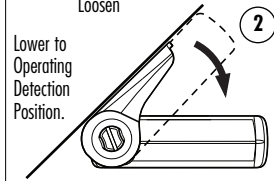

3. Tighten knob to set proper horizontal detection position. The MDU mounting bracket has two detent positions:

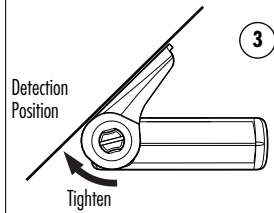

- one for detection operation (horizontal position)
- one for storage or concealment (up position). Makes MDU less visible from outside.

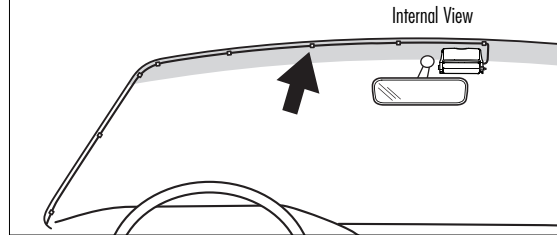

**IMPORTANT:** MDU will not provide any radar/laser detection in "Stored/Concealed" position.

4. Attach power cord to MDU. Use power cord clips to route to fuse box or lighter/accessory outlet, depending on the selected power cord. Surfaces must be clean and free of dirt, oil and dust. Plug in the power cord.

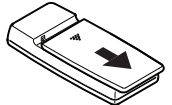

### Remote Display Unit (RDU)

#### Battery Installation

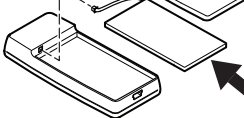
<p>1. Turn RDU over and slide battery cover off the RDU body.</p>	
<p>2. Carefully plug battery wire connector into the battery connection port in RDU. Connector only fits one way.</p>	
<p>3. Replace battery cover.</p>	

#### Battery Charging

The unit is shipped with a sealed lithium-ion (LiION) battery pack that is rechargeable.

**IMPORTANT:** Avoid temperature extremes (hot and/or cold) to help prolong battery life and performance. DO NOT leave RDU exposed to direct sunlight. If the RDU is mounted on vent, clip must be on lower fin to avoid hot air blowing on RDU battery compartment.

**NOTE:** When battery begins to discharge too quickly, it is time to install a new battery.

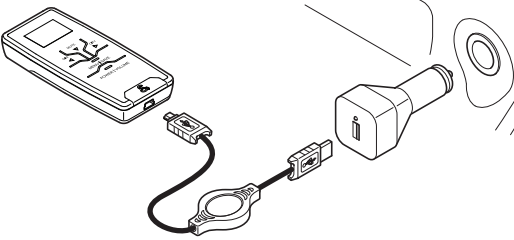
<p>1. Attach 12V to 5V retractable USB power cable to bottom of RDU and to 12V power adapter.</p>	
<p>2. Connect 12V power adapter to vehicle accessory outlet (cigarette lighter plug).</p>	
<p>3. Initial charge for battery is two (2) hours. (RDU may be used while charging.)</p>	
	



#### CAUTION

This lithium-ion (LiION) battery should only be recharged inside the RDU. Do not substitute any other type of charging adapter or charging base to charge the battery. Battery damage, fire or explosion may result.



**NOTE:** Lithium-ion (LiION) batteries are toxic. Please dispose of properly. Some municipal waste disposal agencies have special provisions for battery disposal.



**NOTE:** After battery is fully charged, unit can be operated without retractable power cord until battery needs recharging.



## RDU Holster

A holster is provided to allow you to position the RDU for best driver visibility and for access while charging the battery. A vent or visor clip will attach to the rear of the holster. Self-adhesive hook and loop strips are also included for alternative mounting locations.

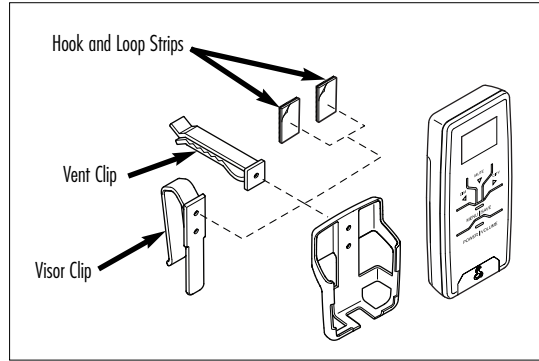

## Global Positioning System Locator (XRS Model R10G Only)

GPS Locator plugs into the USB port on the right side of the MDU.

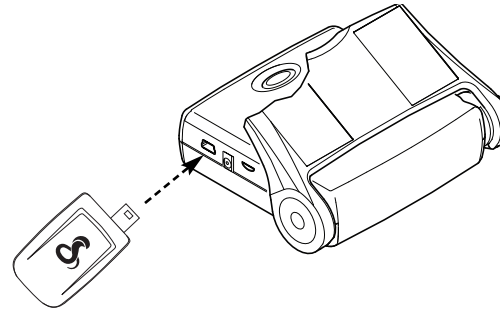

## GPS Locator Initial Satellite Lock

The GPS Locator module now needs to detect the Global Positioning satellites.

1. With vehicle running and parked in an area clear of obstructions to the sky, turn On the power to the MDU with GPS Locator connected.
2. Keep the MDU turned On for at least 15 minutes. This will allow fast satellite acquisition in subsequent power-ups.



GPS Icon

**IMPORTANT:** This procedure may need to be repeated if the unit has not been used for a prolonged period of time.

## RDU Controls

**MUTE/ ▾ Button**  
 Press for Standby Status Screens.  
 Mutes an alert.  
 Selects features in Menu mode.

**DIM/ ◀ Button**  
 Press for display brightness.  
 Navigates Menu Screens.  
 Adjusts volume DOWN in Volume mode.

**MENU/SAVE Button**  
 Press to enter Menu screen.  
 Press and hold to save User Location (XRS R10G only).

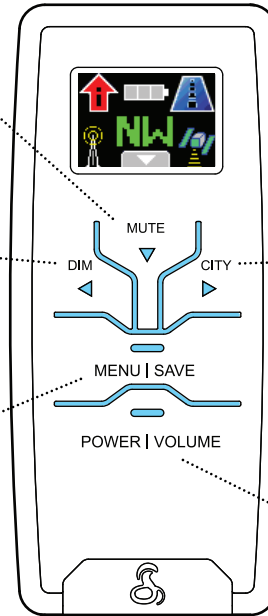

**CITY/ ▶ Button**  
 Toggle between Highway and City modes.  
 Navigates Menu Screens.  
 Adjusts volume UP in Volume mode.

**POWER/VOLUME Button**  
 A two second press and release turns unit On or Off.  
 A momentary press for Volume screen.

## RDU Display

Standby Screen

The IntelliMute (I-Mute) or IntelliMute Pro (I-Mute Pro) symbol shows only if the feature is activated. Arrow changes to indicate if above or below Set-point when I-Mute or I-Mute Pro is turned on. (Refer to page 24.)

RDU battery icon displays charge condition of RDU battery. Sections change to display battery level, or if the battery is being charged.

City/Highway symbol changes to indicate activated alert filtering mode.

The RDU link indicator shows the MDU is connected to the RDU by the wireless link. The indicator changes to show a lost connection.

GPS icon indicates GPS satellite lock. Icon changes to indicate lost signal condition.\*

When arrow is displayed, you can go to the next Standby screens by pushing MUTE/ ▼ button.

Compass indicator uses GPS Locator to indicate direction of travel.\*



**\*Note:** The GPS icon, Compass and other GPS features only display if GPS Locator module is connected (optional for XRS R8, standard on XRS R10G).

## Power On/Off

<p>1. After moving the MDU to its detect position, press the power button on the RDU to turn the system ON.</p>	
<p>2. Unit cycles through power On/self test, then shows RDU battery status, any alert settings changed from factory defaults, wireless connection status and GPS signal status. Finally, the Standby screen is displayed.</p>	
<p>3. Display changes to Auto Dark operating screen after 30 seconds (factory default).</p>	
<p>4. Press, hold power button on RDU for more than two seconds to turn Off the system. The MDU can be turned On/Off and will operate without the RDU.</p>	
<p><b>NOTE</b> If, for any reason, the RDU buttons stop responding, open the battery compartment and press the <b>Reset Button</b>.</p>	<p>Lift battery and press here</p>



## Standby Screens

Press Mute/ ▾ while the Standby screen is displayed to cycle through different Standby screens.

The Standby screens will be displayed in the following order:

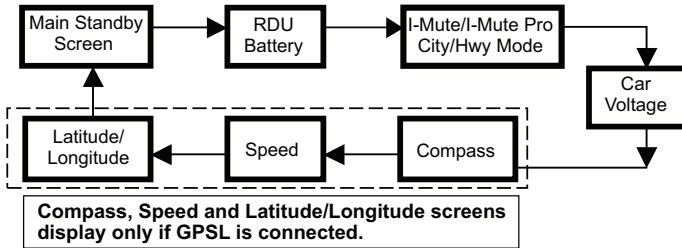

**NOTE:** Last Standby screen viewed will be displayed when exiting Auto Dark mode.



### Main Standby Screen

Standby screen displays information about detector: alert filtering, automatic muting functions and RDU battery status. If GPS Locator is connected, compass heading and GPS status icon also display.



### RDU Battery

RDU Battery screen displays status of RDU battery. Indicates charge left in battery or if it is plugged into power source and is charging.



## I-Mute/I-Mute Pro and City or Hwy Mode

I-Mute screen displays status of alert filtering (City or Highway modes) and automatic muting (IntelliMute or IntelliMute Pro) functions. Refer to related sections to set these features.



## Car Voltage

Car Voltage screen displays voltage level of car battery. If battery voltage drops below 11.9 volts, an alert sounds. Low Car Voltage feature in Alert Settings programming must be activated.

**Screens display only if GPS Locator is connected.**



## Compass

Indicates driving direction.



## Speed

Shows speed of vehicle (may be changed to km/h in Menu).



## Lat/Lon

Displays latitude and longitude of present location.

### Auto Dark



When Auto Dark screen is engaged, a small dot displays at bottom of screen to show that power is on. Touch any button to recall Standby screen. Any alert will also exit Auto Dark mode.

### IntelliShield Highway/City Modes



Your detector is equipped with IntelliShield false signal rejection technology which consists of a **Highway** mode and three different levels of **City** modes: City X, City X Beep Off and City X+K.



Highway mode provides full response to all signals detected. The City modes reduce false alerts while you are driving in or near urban areas where there are many sources for conflicting X or K band signals such as microwave towers and automatic door openers. The factory setting is Highway. The factory City mode default setting is City X; it can be changed in Menu mode (see page 12).

You can toggle between Highway and City modes by pressing the **City** button.



**NOTE:** When you change to City mode, the unit will enter whichever city default mode is set at the time.

### Muting Alerts

#### Manual Mute

Press MUTE/ button momentarily to turn Off Audio Alert during an Alert condition. Press MUTE/ button again during alert to turn On Audio Alert. After current alert is gone, detector will un-mute and next alert sounds.

### Programming Overview

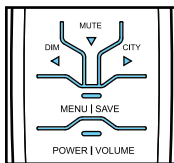

Begin all programming or setup with MENU/SAVE button. Select this to change USER or ALERT settings. USER settings customize how system handles alert filtering, audio-related options, visual options and system-related options. ALERT settings determine which ALERT types are activated. USER and ALERT settings on the XRS R10G model include GPS-related features.

Press MENU/SAVE button again to save feature and function changes and return to Standby screen. If a button is not pressed within 15 seconds while in Setup/Programming mode, Standby screen displays and settings made up to this point are saved automatically.

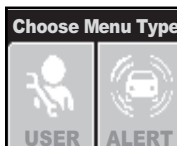

Enter USER or ALERT settings sub-menu and display shows left arrow ◀, down arrow ▼ and right arrow ▶. Arrows correspond with arrows on DIM, MUTE and CITY buttons on RDU.

Press left arrow ◀ to return to previous screen. Press right arrow ▶ to access next screen. Press down arrow ▼ to make changes. Press MENU/SAVE button to exit setup program and save new settings.

Each of these functions and settings are explained in **SETTINGS** section of this manual.



**NOTE:** Advancing at the end of menu returns to beginning of menu.

Setup/Programming mode cannot be accessed during an alert. Unit does not detect signals while in Setup/Programming mode.

You can restore all settings at once to factory state in the USER settings sub-menu.

**Program Flow Diagrams**

**User Settings Diagram**

Screens display in the following order when cycling through User Settings menu. Speed Units screen displays only if GPS Locator is connected to system. Pair RDU screen displays only if system detects a missing RDU connection.

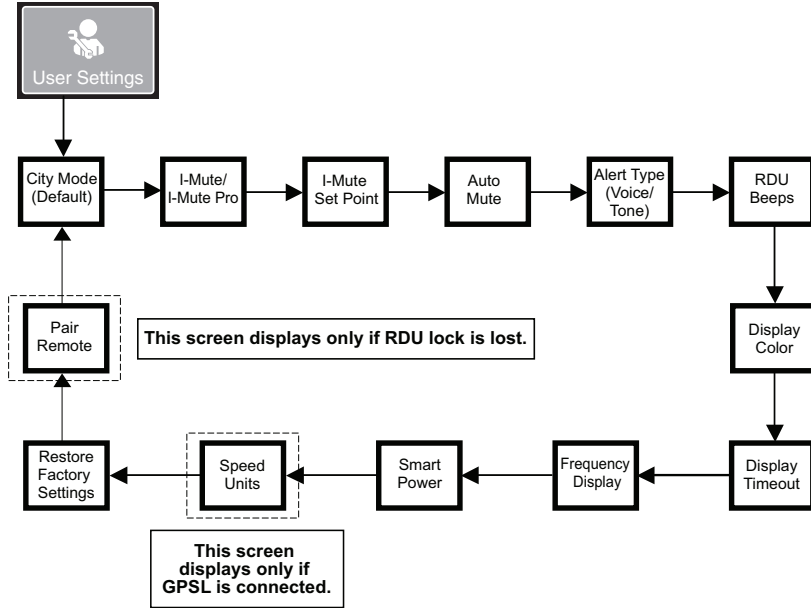

**Alert Settings Diagram**

Screens display in the following order when cycling through Alert Settings menu. Speed Alert, Display GPS Database Version and Delete ALL User Locations screens display only if a GPS Locator is connected to system.

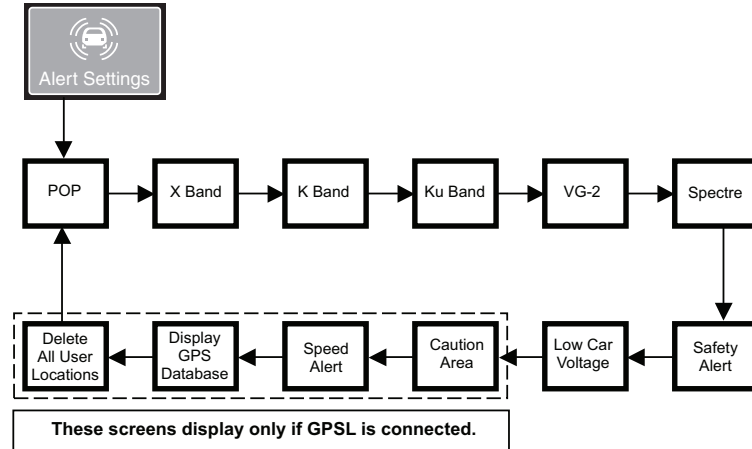

## Programming User Settings

### IntelliShield City Mode Default

**City Mode Default** makes three levels of **Audio Alert** suppression available when you toggle from **Highway** to **City** mode (see page 20). The factory setting is City X.

**City X** sounds a single beep when an X band signal is first detected. The alert then sounds when signal strength reaches level 3.

**City X+K** combines the City X mode with prevention of K band audio alerts until the signal strength reaches level 2.

**City X Beep Off** blocks all X band audio alerts until the signal strength reaches level 3.

The City Mode Default can be changed in Menu mode. It can also be changed at any time the detector is in Standby mode:

1. Press and hold the **City ▶** button for at least two seconds. The three City modes will be sequentially displayed for three seconds each as long as the button is pressed.
2. Release the **City ▶** button while the desired City mode is displayed to set that mode as the default.

### IntelliMute and IntelliMute Pro Modes

**IntelliMute** and **IntelliMute Pro** are two features that are active at slow speeds and when your vehicle is stopped. Both depend on your detector sensing the vehicle's engine "revs" (RPMs) to function. Either feature can be turned On in Menu mode, but not both at the same time. The factory settings are IntelliMute Off and IntelliMute Pro Off.

After turning On IntelliMute or IntelliMute Pro, you must then set an Activation Point for your engine's RPMs (see page 26). Whenever the RPMs are below that point, IntelliMute will begin muting or IntelliMute Pro will turn Off the radar detection circuits. The Activation Point will be stored in memory and recalled each time the power is turned On.

**NOTE:** IntelliMute and IntelliMute Pro may not work with some vehicles because the unit cannot sense the engine's RPMs. In such a case, Auto Mute and City mode can reduce some unwanted audio alerts.

### IntelliMute Mode

**IntelliMute** allows you to avoid audio alerts you don't need to hear because you are stopped or moving slowly. By sensing the RPMs of your engine, IntelliMute knows when you are at low speed and automatically mutes alerts (except for strobe signals from emergency vehicles). It works with all City and Auto Mute modes.

The IntelliMute icon will appear in the display when IntelliMute is On and the activation point has been set. Whenever engine RPMs are below the Activation Point, the arrow points down. When RPMs are above the Activation Point the arrow points up.



Below Activation Point



Above Activation Point

### IntelliMute Pro Mode

**IntelliMute Pro** prevents detection by radar detector detectors (RDDs) such as VG-2, Spectre I and Spectre IV+ when traveling at slower speeds. It is intended for use by experienced users only.

When IntelliMute Pro is turned On, and engine RPMs are below the IntelliMute Pro Activation Point, your detector's radar detection circuits are turned Off to prevent detection by RDDs.

The IntelliMute Pro icon will appear in the display when IntelliMute Pro is On and the Activation Point has been set. Whenever engine RPMs are below the Activation Point, the arrow points down with the "i" blinking. When RPMs are above the Activation Point the arrow points up with the "i" blinking.



Below Activation Point

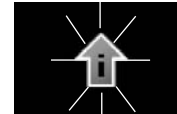

Above Activation Point



#### CAUTION

When IntelliMute Pro is On, **NO** radar signals will be detected and **NO** alerts will be given at RPMs **below** the IntelliMute Pro activation point.

### Set Activation Point

After the detector is installed in your vehicle and **IntelliMute** or **IntelliMute Pro** is turned On using Menu mode, press the **City** ► button to advance to the IntelliMute Set Point screen where the Activation Point can be set.

At the Set Point screen:

1. Press the **Mute** ▼ button to advance to the Setup screen.
2. Press and hold the vehicle accelerator at the desired engine RPMs.
3. Press the **Mute** ▼ button to complete the setting process.

The system will store the engine RPM setting and provide a completion message on the display as well as a tone or voice message.

 **NOTE:** If the unit is unable to sense usable pulses within three seconds or if you do not set a rev point within 30 seconds of beginning the setup, IntelliMute or IntelliMute Pro will indicate an error. If you do not try again within five seconds, it will automatically turn Off. The unit will provide corresponding messages for these conditions.

Once an activation point has been set, you can easily change it by going to IntelliMute / IntelliMute Pro in User Settings Menu and repeating the three-step setup process.

If, for any reason, the unit stops sensing your engine's revs, IntelliMute or IntelliMute Pro will indicate an error and automatically turn Off.

 **NOTE:** When initially choosing your IntelliMute or IntelliMute Pro Activation Point, a setting of approximately 300 to 600 RPMs above idle is recommended.

 **NOTE:** The rev point must be reset if you use your detector in a different vehicle.

 **CAUTION**  
Do not attempt to set the rev point while driving. Your vehicle should be parked and idling to avoid a collision during the process.

### Auto Mute Mode

When **Auto Mute** is on, it automatically reduces the audio volume of all alerts after they have sounded for four seconds. The signals will remain muted for as long as the signal is detected. When Auto Mute is off, the alerts will sound at full volume for as long as the signal is detected. The factory setting for Auto Mute is On. Press MUTE/ ▼ to toggle between Auto Mute vs. Manual Mute.

### Voice or Tone Mode

Set detector to sound alerts and confirm program settings with a Voice or a Tone. Voice Alert provides voice messages in addition to tones. Tone Alert provides tones only. Factory setting is Voice Alert.

### Remote Display Unit (RDU) Beep Level

RDU Beep sets the volume level for the keypad confirmation tones of the RDU. Choose from Low, High or Off RDU beep level volumes.

### RDU Display Color

The RDU screen color theme is customizable to match your personal preference or your vehicle's dash illumination. Choices include Multi-Color, Red, Blue, Orange or Green. Factory setting is Multi-Color.

### Display Timeout

Display Timeout determines how long RDU button backlight and display stays On before RDU screen switches to Auto Dark mode. Set RDU display time for 15 seconds, 30 seconds, one minute, three minutes or Always On. Factory default is 30 seconds.

 **NOTE:** If selecting "Always On" setting, RDU battery will need charging more frequently.

### Frequency Display Mode

Different Ka radar and LIDAR (Laser) guns operate at various frequencies within their assigned spectrums. When Frequency Display is turned On, the signal frequency will be added to the alert. The factory setting for Frequency Display is Off.





## Smart Power Mode

SmartPower feature turns system Off five minutes after car's engine is turned off. Before SmartPower engages, three beeps sound and SmartPower flashes on display. Start the car or press Power/Pairing button to return to normal power. Factory setting is SmartPower OFF.

## Speed Indicator (Shown only if GPS Locator is connected)

Displays vehicle speed in miles per hour (MPH) or kilometers per hour (km/h). Factory setting is MPH.

## Restore Factory Settings

Restore detector to original settings here. Confirmation messages display during process.

## Pair Remote

If the MDU and RDU are not paired by wireless link, this User Settings menu item can be used to establish the link.

## Programming Alert Settings

---

### POP Alert

With Pop Detect mode on, signals are detected and an alert given. During alert unit continues to detect other signals. Factory setting is Pop Detect Off.

### X Band Alert

With X Band Detect mode on, signals are detected and an alert given. During alert unit continues to detect other signals. Factory setting is X Band Detection On.

### K Band Alert

With K Band Detect mode on, signals are detected and an alert given. During alert unit continues to detect other signals. Factory setting is K Band Detect On.

### Ku Band Alert

With Ku Band Detect mode on, signals are detected and an alert given. During alert unit continues to detect other signals. Factory setting is Ku Band Detect Off.



## VG-2 Alert

Detector is undetectable by VG-2 detection devices. An alert is given when such a device is in use near the vehicle. When VG-2 Detect mode is On, VG-2 signals are detected and an alert given. During alert unit continues to detect other signals. Factory setting is VG-2 Detect Off.

## VG-2 Audio Mode

When VG-2 Audio mode is On, alerts are heard and displayed. This setting is only available if VG-2 Alert is On. Factory setting is VG-2 Audio Off.

## Spectre I & IV+ Alerts

Police use radar detector detectors (RDDs) to spot users of radar detectors. Your detector is able to identify signals from **Spectre I** and **Spectre IV+** RDDs and can provide alerts when any of these or similar devices are in use near your vehicle.

Your detector **can** be spotted by Spectre IV+ RDDs, but is invisible to Spectre I RDDs. You can choose whether you want to be alerted to Spectre I & IV+ RDD signals. The factory setting is Spectre Detect Off.

## Spectre Audio Mode

When **Spectre Audio** mode is on, alerts will be sounded as well as being displayed on the screen. This setting is only available if Spectre Alert is on. The factory setting is Spectre Audio off.

## Safety Alert

When Safety Alert mode is On, Safety Alert radar signals are detected and an alert is given. During alert unit continues to detect other signals. Factory setting is Safety Alert On.

## Low Car Voltage Warning

Many U.S. cars have continuous power to 12V outlet and if a device is connected/kept on, it will drain vehicle's battery. To avoid this, XRS R8/R10G comes with SmartPower and Low Car Voltage Warning features.

The detector emits a car battery low alert when voltage drops below 11.9 volts. The detector enters SmartPower mode to avoid further battery draining. Factory setting is Car Battery Low OFF.



The following functions are available only if a Global Positioning System Locator is connected to the system.

### Caution Area Alerts

If you have turned Caution Area Alert On, whenever your vehicle approaches a caution area (such as a high-accident intersection) contained in the built-in GPS Locator database, an alarm will be provided with a unique chime and the Caution icon will become progressively larger as you approach the location. The factory setting is Caution Area Alert Off.

### Speed Alert

The Speed Alert with the GPS Locator module tracks vehicle speed and sounds an alert when set speed is exceeded. Speed settings increase or decrease in 5 MPH or km/h increments, depending upon Speed Units chosen in User Settings. Speed Alert must be turned On to see Adjust Speed Setting screen. Factory setting is Off.

### Display GPS Database Date

The GPS database screen is only informational. The screen changes only when you have updated the database.

### Delete all User Locations

Delete all user-programmed location alerts with this screen.

## Detection Alerts

### Alert Screens

All alerts have a unique tone and a vocal alert if the Voice Alert feature is activated. The numbers from 1 to 5 next to the radar signal type indicate signal strength from lowest to highest.

### Radar Alerts

Radar alerts for X band, Ku band, K band and Ka band generate a screen display "RADAR," signal type and a number (1-5) indicating the signal strength. A unique tone sounds with a vocal alert if the Voice Alert feature is activated.



POP, VG2, SP1 or SP4 display depending on signal type detected.



### Laser Alerts

Laser alerts are indicated by an "L" and laser signal type. Other Laser types will be indicated by the word LASER as shown in the display at the right.



### Frequency Display Mode

Various Ka radar band and LIDAR (Laser) guns are made to operate at different frequencies within the spectrums assigned to them. When these signals are detected, their frequencies will be added at the top of the display screen, when this feature is enabled.

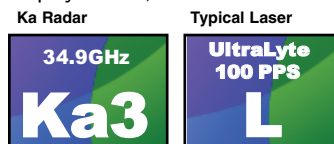



## Detection Alerts



### Emergency Vehicle Alerts

Emergency vehicle alerts are indicated by “EV” and the label “EMERGENCY.”



### Road Hazard Alerts

Road Hazard alerts show “RH” and “ROAD HAZARD.”



### Railroad Alerts

Railroad alerts generate “RR” and “RAILROAD.”



### Low Car Voltage Alert

The detector emits a car battery low alert when voltage drops below 11.9 volts. The detector enters SmartPower mode to avoid further battery draining.

*The following screens are shown only if a Global Positioning System Locator is connected to the system.*

A detector system with a GPS Locator also provides alerts based on vehicle location and information in its databases. The icon increases in size as described. In Multi-Color theme, the icon also changes from green, to yellow, to red.



### Photo Enforcement Alerts

An alert to a Photo Enforcement area is indicated by a camera surrounded by a circle. As you get closer to the photo enforced location (automated speed and red light cameras), the circle and the camera get progressively larger and you hear a unique chime. If the Voice Alert is activated you will also hear a voice alert.



## Detection Alerts



### Caution Area Alerts

An alert to a Caution Area (such as speed traps and high-accident intersections) is indicated by an exclamation point surrounded by a circle. As you get closer to the progressively larger and you hear a unique chime. If the Voice Alert is activated, you will also hear a voice alert.



### User Location Alerts

The system can store up to 1,000 User Programmable Location Alerts set to give hazard warnings not known to the GPS Locator database. The screen displays a flag surrounded by a circle. When approaching a stored location, the circle and flag get progressively larger. In addition, a unique tone sounds as vehicle approaches location. A voice alert sounds if Voice Alert is activated. User Alerts can be saved by pressing and holding the MENU/SAVE button for 2 seconds.



**NOTE:** A particular User Location can be deleted only when the vehicle returns to that location and receives a User Location Alert. Press MENU/SAVE to delete that location.

A confirmation screen displays with “Yes” and “No” selections. Press “Yes” to confirm User Location Deleted. Press “No” to cancel delete. All User Locations can be deleted at once in Program Alert Settings.

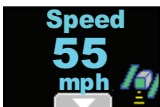

### Speed Alerts

Speed alerts are generated when the GPS Locator senses the vehicle is going faster than the speed setting programmed in the Alert Setting menu. The display indicates actual vehicle speed and a tone sounds. All radar, laser, strobe and safety alerts have priority and override this alert.



## IntelliScope

In conjunction with detection of a Location Based Alert, **IntelliScope** provides information about the direction of the Location relative to your moving vehicle.

The following descriptions use a **Photo Enforced** location as an example. In **Caution Areas** and **User Locations** their signal icons and related text will substitute for the Photo Enforced ones shown in these examples.

Three screens will sequence on the display to identify the type and direction of the location generating the alert. The continuous part of the sequence will repeat as long as the alert is active.

### Screen Sequence In Zone 1 For Location Straight Ahead

As a location is approached, the arrows will point to the location while alternating with the alert icon and text as shown in the sequence below. The sequence will repeat as long as the alert is active.

Begin Alert



Continuous Alert



### IntelliScope Alert Arrow Sequence For A Location Directly Ahead

While approaching a Photo Enforcement Location on your route that is directly ahead.



**NOTE** The arrow disappears in Zone 3 when you are close to the Location.



## IntelliScope Alert Arrow Sequence When You Turn Toward The Location

While approaching a Photo Enforcement Location involving a turn onto a cross street where it is located.



**NOTE** The arrow disappears in Zone 3 when you are close to the Location.

## IntelliScope Alert Arrow Sequence When A Location Is Off Your Route

While approaching and passing a Photo Enforcement Location that is some distance away to the right of your route.



**NOTE** The signal never enters Zone 3 since you never come close to the Location.



## Understanding Radar and Laser

### Radars Speed Monitoring Systems

Three band frequencies have been approved by the Federal Communications Commission (FCC) for use by speed monitoring radar equipment:

<b>X band</b>	10.525 GHz
<b>K band</b>	24.150 GHz
<b>Ka band</b>	33.400 – 36.00 GHz

Your detector detects signals in all three radar bands, plus Ku band (13.435 GHz), which is an approved frequency used in parts of Europe and Asia.

### VG-2 and Spectre

**VG-2** and **Spectre I & IV+** are radar detector detectors (RDDs) that work by detecting low-level signals emitted by most radar detectors. Your detector does not emit signals that can be spotted by VG-2 and Spectre I RDDs. However, your detector **can** be spotted by Spectre IV+ RDDs. Your unit detects signals from these or similar devices and will alert you when such a device is in use near your vehicle.

### Safety Alert Traffic Warning System

FCC-approved Safety Alert transmitters emit microwave radar signals that indicate the presence of a safety-related concern. Depending on the frequency of the signal emitted, it can indicate a speeding emergency vehicle, train or a stationary road hazard.

Because these microwave signals are within the K band frequency, most conventional radar detectors detect Safety Alert signals as standard K band radar. Your detector, however, is designed to differentiate between standard K band and Safety Alert signals, and give separate alerts for each.

Safety Alert technology is relatively new. Safety Alert transmitters can be found in limited numbers in all 50 states, but the number is growing. Depending on your location, you may not receive these alerts regularly and may often encounter emergency vehicles, trains and road hazards without being alerted. As the number of transmitters increases, these alerts will become more common.

When you receive such an alert, watch for emergency vehicles ahead of you, on cross streets or behind you. If you see an emergency vehicle approaching, pull over to the right side of the road and allow it to pass.

### Strobe Alert

Special strobes mounted on the light bars of authorized emergency vehicles (fire trucks, police cars, ambulances) automatically change traffic signals as the vehicle approaches an intersection. These strobes and the special strobe detectors located on the traffic signals are already in use in more than 1000 cities nationwide. Cobra's exclusive Strobe Alert detector detects these special strobes and sounds an emergency vehicle alert.

When you receive such an alert, watch for an approaching emergency vehicle and pull over to allow it to pass. Contact your local fire and police departments for information about coverage in your area.

### LIDAR (Laser)

The correct name for the technology that most people refer to as "laser" is actually LIDAR, Light Detection And Ranging. LIDAR operates much like radar. Its signal spreads out like a radar signal, though not as widely. Unlike radar, LIDAR must have a clear line of sight to its target vehicle throughout the entire measurement interval. Obstructions such as sign posts, utility poles or tree branches prevent valid speed measurement.

#### Some common questions about LIDAR include:

- **Does weather have any affect on LIDAR?**  
Yes. Rain, snow, smoke, fog or airborne dust particles reduce the effective range of LIDAR and can, with dense conditions, prevent its operation.
- **Can LIDAR operate through glass?**  
Yes. Newer LIDAR guns can obtain readings through most types of glass. However, the laser pulse also can be received through glass to trigger an alarm by your detector.
- **Can LIDAR operate while in motion?**  
No. Because LIDAR operates by line of sight, the person using it cannot drive the vehicle, aim and operate the gun all at the same time.
- **Is LIDAR legal to use?**  
Yes. It is legal in all 50 states.



## Pop Radar Guns

The Pop Mode Radar Gun is a single-pulse Doppler radar that is a feature of a Ka (Bee III Ka radar gun) band Instant-On radar gun. It uses a single, short-time pulse to measure the target vehicle's speed.

The Pop mode receiver senses Pop signals beyond the effective range of Pop radar guns. As the Pop mode receiver is so sensitive, you should limit the use of Pop Detect mode to highway and rural driving. As such, factory default is set to OFF.

## Maintenance

Detector is designed and built to give years of trouble-free performance without service. No routine maintenance is required.

Follow these steps if unit is not operating properly:

- Make sure power cord is properly connected.
- Make sure lighter/accessory outlet of vehicle is clean and free of corrosion.
- Make sure power cord's accessory adapter is firmly seated in lighter/accessory outlet.
- Check power cord fuse (unscrew ribbed end cap of accessory adapter and examine fuse) or in-line fuse of cable to fuse box, depending on cord used. If required, replace with 2-amp fuse only.

**NOTE:** Rechargeable battery packs should be recycled or disposed of properly in compliance with all applicable laws. Certain states or municipalities provide recycling and have established collection programs. Please contact your local waste removal authority for instructions.



### WARNING

Do Not put battery packs into fire or expose to high heat. They may explode.



### CAUTION

To reduce risk of damage, use only approved battery packs.

## Band and Frequencies

Band	Frequencies		
X Band	10.525	± 0.050	GHz
K Band	24.125	± 0.125	GHz
Safety Alert Traffic Warning System	24.070	± 0.010	GHz
	24.110	± 0.010	GHz
	24.190	± 0.010	GHz
	24.230	± 0.010	GHz
Ka Band	34.700	± 1.300	GHz
Ku Band	13.435	± 0.050	GHz
VG-2	11.500	± 0.250	GHz
Spectre I	13.300	± 0.200	GHz
Spectre IV+	Not Disclosed		
Laser	910	± 50	nm
Strobe	700	± 300	nm

This radar detector is covered by one or more of the following U.S. patents: 5,497,148; 5,594,432; 5,612,685; 6,078,279; 6,094,148; 6,621,447. Additional patents may be listed inside the product or pending.



**NOTE:** This device complies with part 15 of FCC rules: Operation is subject to the following two conditions: (1) This device may not cause harmful interference, and (2) This device must accept any interference received including interference that may cause undesired operation.



### Product Service

For questions about operating or installing this new Cobra product, or if parts are missing... **CALL COBRA FIRST**...do not return this product to the store.

If this product should require factory service, call Cobra before sending the product. This will ensure the fastest turn-around time on any repair. If Cobra asks that the product be sent to its factory, the following must be furnished to have the product serviced and returned.

1. For Warranty Repair, include some form of proof-of-purchase, such as a mechanical reproduction or carbon of a sales receipt. Make sure the date of purchase and product model number is clearly readable. If the originals are sent, they cannot be returned.
2. Send the entire product except for hardwired or permanently placed components such as 12V hardwire power cord and cord clips.
3. Enclose a description of what is happening with the product. Include a typed or clearly printed name and address of where the product is to be returned, with phone number (required for shipment).
4. Pack product securely to prevent damage in transit. If possible, use the original packing material.
5. Ship prepaid and insured by way of a traceable carrier such as United Parcel Service (UPS) or Priority Mail to avoid loss in transit to:  
Cobra Factory Service  
Cobra Electronics Corporation  
6500 West Cortland Street  
Chicago, Illinois 60707 U.S.A.
6. If the product is in warranty, upon receipt of the product, it will either be repaired or exchanged depending on the model. Please allow approximately 3 – 4 weeks before contacting Cobra for status. If the product is out of warranty, a letter will automatically be sent with information as to the repair charge or replacement charge.

**For any questions, please call 773-889-3087 for assistance.**



### Warranty

COBRA ELECTRONICS CORPORATION warrants that its products, and the component parts thereof, will be free of defects in workmanship and materials for a term of one year from the date of first consumer purchase. This warranty may be enforced by the first consumer purchaser, provided that the product is used solely within the U.S.A. and Canada.

Cobra will, without charge, repair or replace, at its option, defective products or component parts upon delivery to the Cobra Factory Service Department, accompanied by proof of the date of first consumer purchase, such as a duplicated copy of a sales receipt. The consumer must pay any initial shipping charges required to ship the product for warranty service. Return charges will be at Cobra's expense, if the product is repaired or replaced under warranty.

This warranty gives the consumer specific rights, and he or she may also have other rights which vary from state to state.



**NOTE:** Cobra makes no warranty as to the accuracy or completeness of the data in the products and disclaims any and all express, implied or statutory warranties, including any implied warranty of merchantability or fitness for a particular purpose.

#### EXCLUSIONS – This limited warranty does not apply:

1. To any product damaged by accident;
2. In the event of misuse or abuse of the product or as a result of unauthorized alterations or repairs;
3. If the serial number has been altered, defaced or removed;
4. If the owner of the product resides outside the U.S.A. and Canada.

All implied warranties, including warranties of merchantability and fitness for a particular purpose are limited in duration to the length of this warranty. COBRA SHALL NOT BE LIABLE FOR ANY INCIDENTAL, CONSEQUENTIAL OR OTHER DAMAGES; INCLUDING, WITHOUT LIMITATION, DAMAGES RESULTING FROM LOSS OF USE OR COST OF INSTALLATION. Some states do not allow limitations on the duration of an implied warranty and/or do not allow the exclusion or limitation of incidental or consequential damages, so the above limitations may not apply to some consumers.

It is the user's responsibility to use this product prudently and responsibly. This product is intended to be used only as a travel aid and must not be used or any purpose requiring precise measurement of direction, distance, location or topography.





### User License

This document and the software and data described in it are furnished under license and may be used or copied only in accordance with such license.

Except as permitted by such license, the contents of this document, software and data may not be disclosed to third parties, copied or duplicated in any form, in whole or in part, without the prior written permission of Cobra Electronics Corporation. This document, software and DATA contain proprietary and confidential information of Cobra Electronics Corporation and its licensors.

Cobra grants the purchaser a limited license for use of this document, software and data incorporated in its products for personal use, and not for resale, sublicense or commercial use. **By using this product, the purchaser agrees to be bound by the terms and conditions of this license agreement.** The purchaser acknowledges that the content of this document, software and data are the property of Cobra and its licensors and are protected by copyright laws of the USA and international treaties. The purchaser agrees not to modify, decompile, disassemble, reverse engineer or reduce to human readable form the software, DATA or any part thereof, nor to create derivative works based on the contents of the document, software or data, nor remove or obscure any copyright, trademark notice, or restrictive legend. The purchaser agrees not to export or re-export this document or this product to any country in violation of the export control laws of the U.S.A.

The contents of this document, software and data are for informational use only and are subject to change without notice. Cobra and its licensors intend to provide their customers the most complete and accurate information available at a reasonable cost from government and private data sources. However, all data sources have limitations and some have inaccuracies or are incomplete to some degree. These characteristics carry over to this product as well. As such, COBRA AND ITS LICENSORS DO NOT MAKE ANY REPRESENTATION OR WARRANTY REGARDING THE ACCURACY OR COMPLETENESS OF ANY DATABASE USED BY THIS PRODUCT AND SHALL NOT BE LIABLE TO THE USER FOR ANY INCIDENTAL, CONSEQUENTIAL, SPECIAL, INDIRECT OR EXEMPLARY DAMAGES INCLUDING ANY FINES, CIVIL OR CRIMINAL PENALTIES ARISING FROM THE USE OF THIS PRODUCT.



THIS PRODUCT IS PROVIDED ON AN "AS IS" AND "WITH ALL FAULTS BASIS" AND COBRA AND LICENSOR EXPRESSLY DISCLAIM ALL WARRANTIES, EXPRESS OR IMPLIED, INCLUDING BUT NOT LIMITED TO, THE IMPLIED WARRANTIES OF NON-INFRINGEMENT, MERCHANTABILITY, QUALITY, ACCURACY, TITLE AND FITNESS FOR A PARTICULAR PURPOSE. NO ORAL OR WRITTEN ADVICE OR INFORMATION PROVIDED BY COBRA AND/OR ITS LICENSORS OR ANY OF THEIR AGENTS, EMPLOYEES OR THIRD PARTY PROVIDERS SHALL CREATE A WARRANTY, AND USER IS NOT ENTITLED TO RELY ON ANY SUCH ADVICE OR INFORMATION. THIS DISCLAIMER OF WARRANTIES IS AN ESSENTIAL CONDITION OF THE AGREEMENT.

Cobra encourages customers to report any errors found in our data by contacting technical assistance (available in English and Spanish) at product info@cobra.com (e-mail), by visiting our website: www.cobra.com, or by calling customer assistance (available in English and Spanish) at 773-889-3087 between 8:00 a.m. and 6:00 p.m. Central Time, Monday through Friday (except holidays).

If End User is the United States Government, then use, reproduction or disclosure of this commercial product and accompanying documentation may be subject to DFARS 252.227-7014(a)(1); DFARS 227.7202-1; FAR 52.227-19; DFARS 252.227-7015; FAR 52.227-14 Alternates I, II, and III; and/or FAR 12.211 and FAR 12.212 as applicable and/or similar successor clauses in FAR, or the DOD or NASA FAR Supplement.

Use of this product is not a substitute for careful driving. It is the responsibility of the vehicle operator to operate his/her vehicle in a safe and lawful manner. QUALITY, ACCURACY, TITLE AND FITNESS FOR A PARTICULAR PURPOSE. NO ORAL OR WRITTEN ADVICE OR INFORMATION PROVIDED BY COBRA AND/OR ITS LICENSORS OR ANY OF THEIR AGENTS, EMPLOYEES OR THIRD PARTY PROVIDERS SHALL CREATE A WARRANTY AND USER IS NOT ENTITLED TO RELY ON ANY SUCH ADVICE OR INFORMATION. THIS DISCLAIMER OF WARRANTIES IS AN ESSENTIAL CONDITION OF THE AGREEMENT.



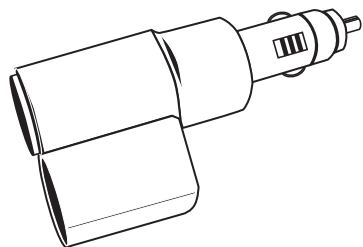

**Dual Port Power Adapter**

Includes adjustable plug (up to 90°) and fuse

Item #CLP-2B



**Plug-in GPS Locator Unit  
(for Model XRS R8 Only)**

Item #RDA GPSL55

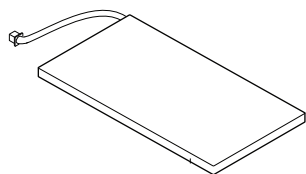

**LiION Replacement Battery Pack**

Item #RDA LIBP

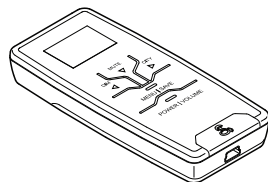

**Replacement RDU**

Item #RDA RDU